

** Please return form to your sales representative or fax to Hi-Tech Seals @ 1.800.465.5866*

DK109



Contact Information

Name: _____

Company: _____

Address: _____

Email: _____

Seal Dimensions

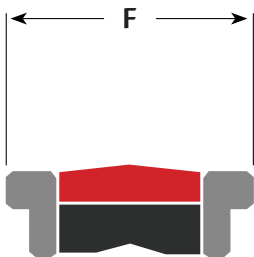

Hardware Dimensions

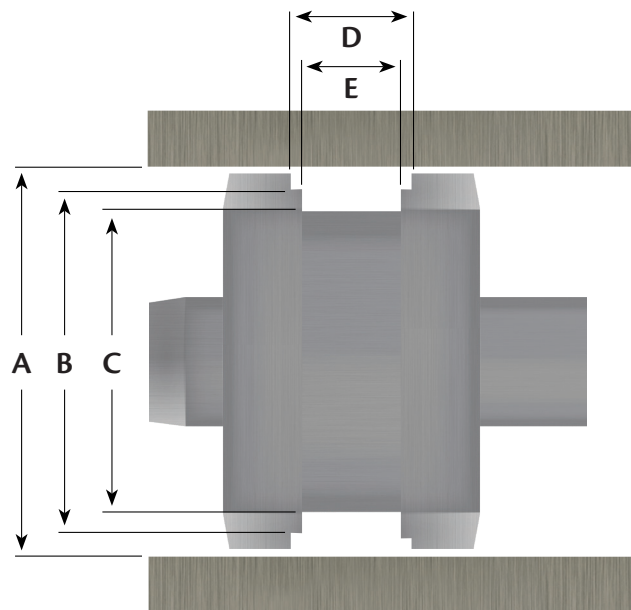

A: _____

B: _____

C: _____

D: _____

E: _____

F: _____

Material: _____

Additional Notes: _____

